

Clearway™

FLEXIBLE DOORS & CURTAINS

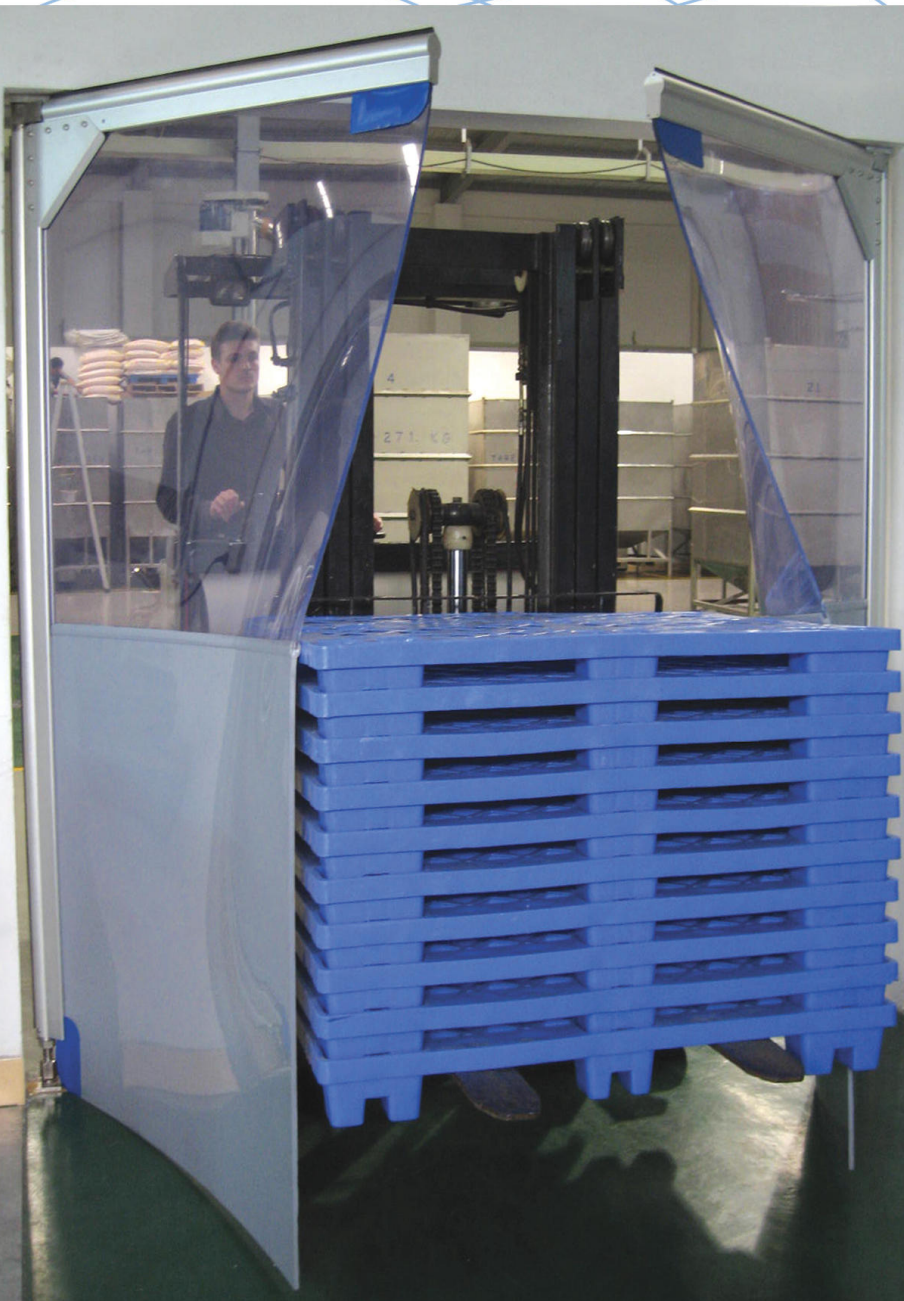

Strip door   Swing door



STRIP & SWING DOORS HARDWARE

WHY USE FLEXIBLE PVC STRIP & SWING DOORS ?

- Easy traffic flow
- Energy efficient
- Economic
- Safely
- Transparent or opaque
- Sound reduction
- Birds, rodents and bugs barriers
- Easy to install and maintain
- Esthetic

WHERE USE FLEXIBLE PVC STRIP & SWING DOORS ?

- Factories
- Cool rooms & Freezers
- Food processing plants
- Warehouses
- Distribution centers
- Supermarkets & retail shops
- Loading docks
- Production process line
- Refrigerated trucks

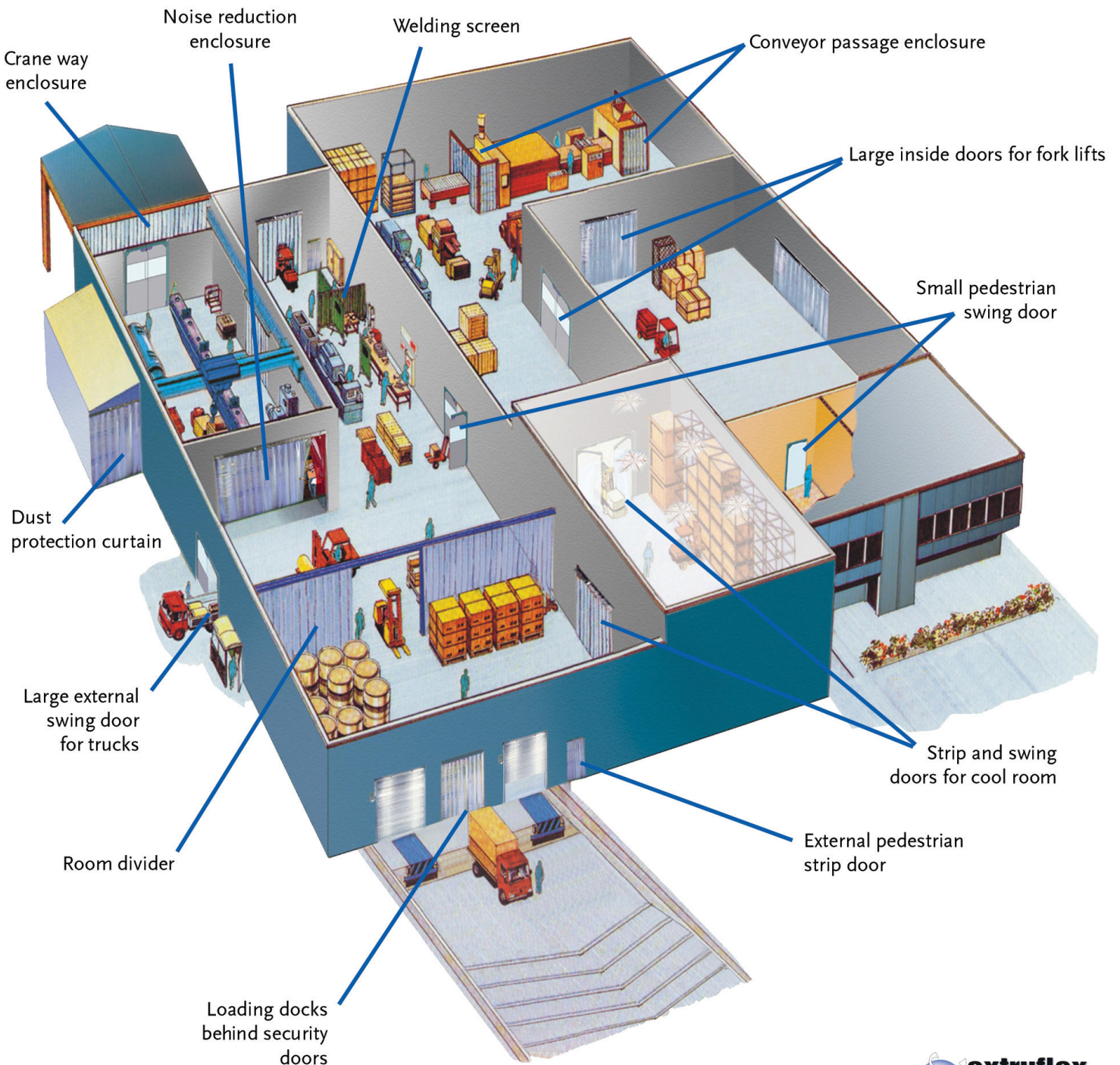

STRIP DOOR HARDWARE

STRIP DOORS

Flexible PVC strip doors provide the most cost effective, fast flowing, safe, and simplest solutions to protect people in their working environment from outside weather conditions. They are excellent barriers against draught, noise, dust, bugs, birds and other nuisances. Strip doors are easy to install and maintain. Strips give you clear vision for safe, easy and free traffic flow as well as daylight saving.

FLEXIBLE PVC STRIP QUALITY

From a wide range of flexible PVC strips available, choose the right strips according to the application :

- For temperature & noise control.....Standard clear
- For cool rooms.....Polar & Super polar
- For heavy traffic.....Ribbed strips
- For welding screens.....Screenflex
- For tropical regions.....Anti-insect yellow
- For identifying opening edges.....Signal red

***All our products are UV treated for anti ageing, non carcinogenic and odourless.**

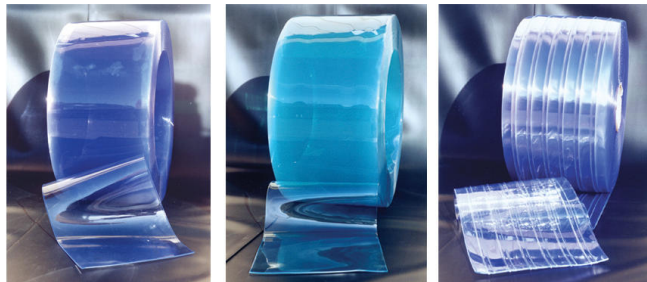

Standard clear Polar strip Ribbed strip

STRIP SIZES

According to the size of the opening, the correct width and thickness for standard or ribbed strip have to be chosen: 100 x 2mm, 200 x 2mm, 300 x 3mm, 400 x 4mm.

Height and traffic type (pedestrian or vehicle) is the most important consideration.

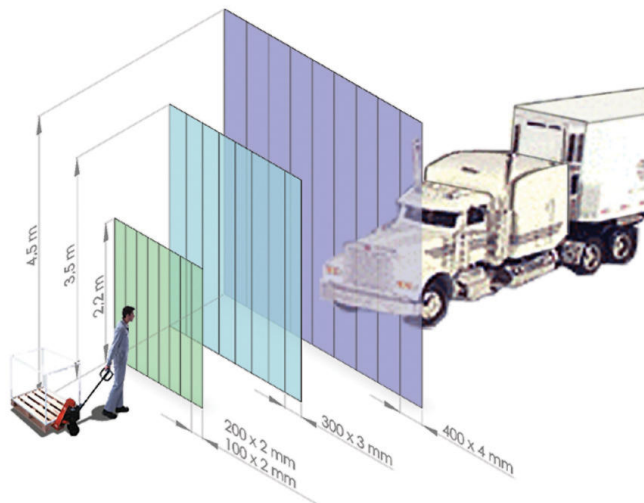

Anti-insect yellow



Signal red

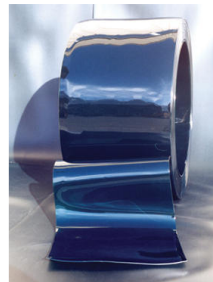

Screenflex

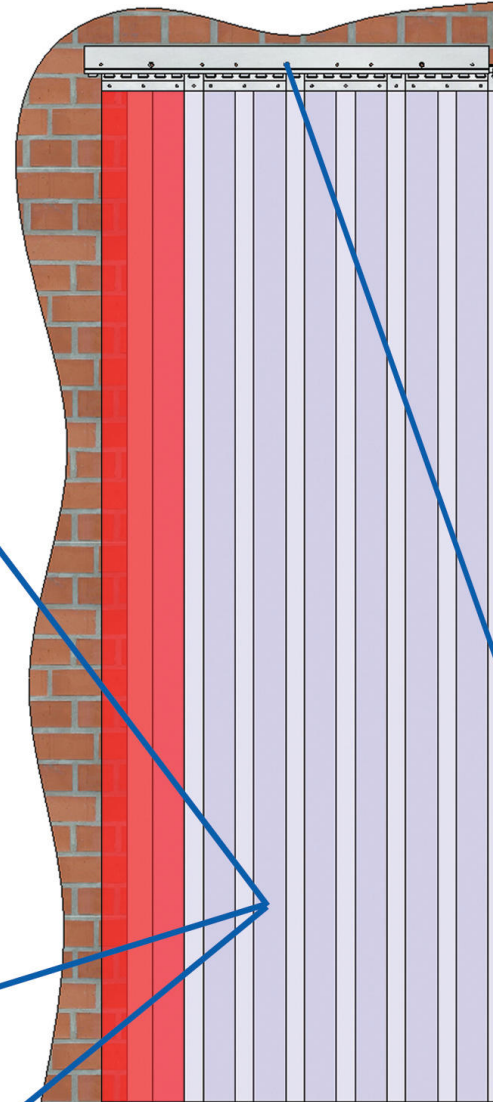

STRIP OVERLAPPING

In order to get a better performance from the doors, a certain percentage of strip overlapping is recommended depending on their use.

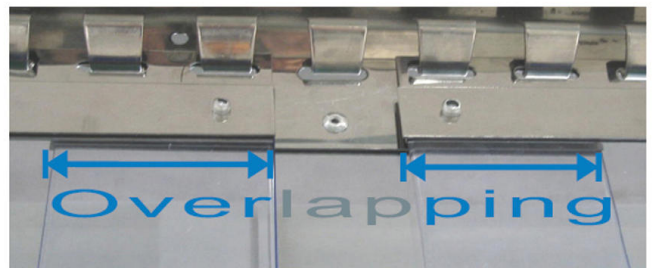

Overlapping choice has to be made according to the isolation needs, from a slight overlapping for a simple separation to 100% overlapping for a strong isolation.

Strip overlapping possibilities :

- 100 mm : 36%
- 200 mm : 36% - 77% - 98%
- 300 mm : 9% - 36% - 63% - 91%
- 400 mm : 16% - 36% - 57% - 77% - 98%

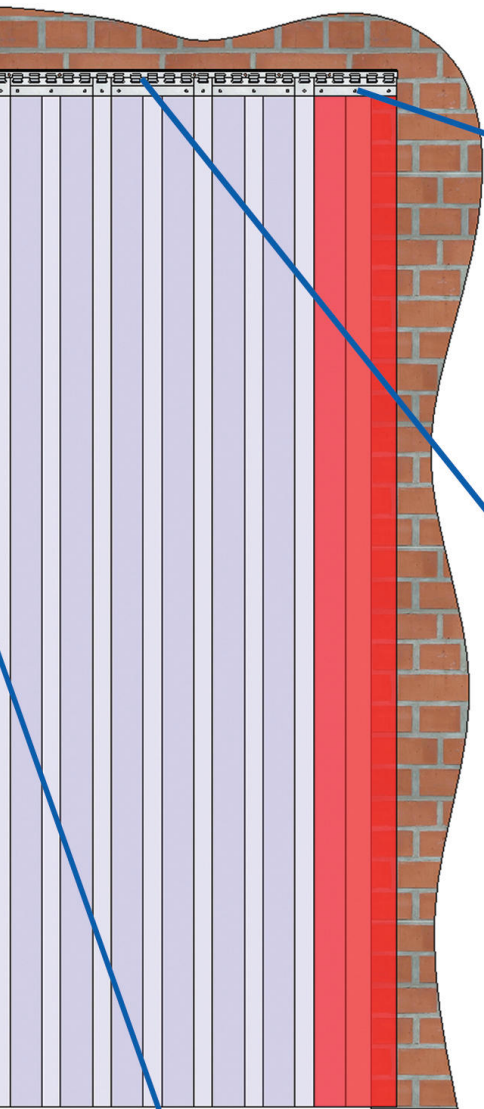

STRIP DOOR HARDWARE

All components of the hanging system are available in top quality stainless steel especially for food or chemical factories and aggressive environments.

PLATE SETS

The strips are fixed between plate sets which swing freely on the hooks of the rail, this avoids any damage and ensures long life.

Matching: 400mm / 300mm / 200mm / 100mm

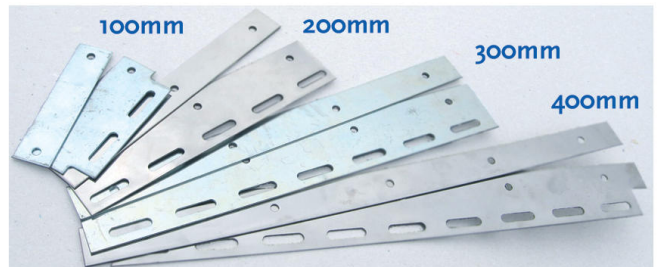

STANDARD DUTY HOOK-ON-TRACK

Hung on hooks with plate sets, the strips are very easily installed, and can be replaced or removed as necessary.



HEAVY DUTY HOOK-ON-TRACK

The heavy-duty hook-on-track is especially designed for large doors with vehicle traffic, 2,5 to 4,5 m high doors using strips 300x3 mm or 400x4 mm. With reinforcing plate, it prevents strips coming off the hooks.

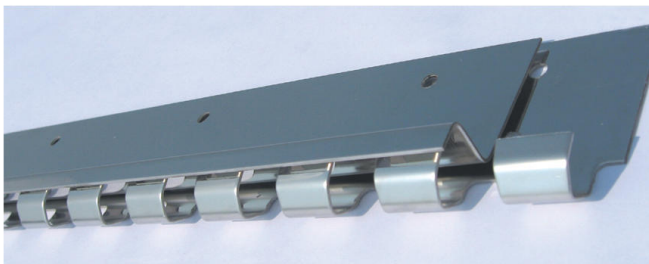

Mounting options :

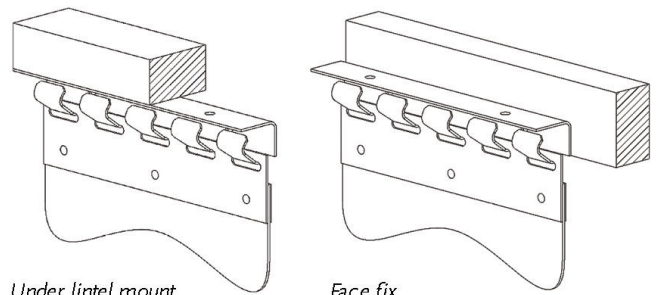

Under lintel mount

Face fix

SWING DOOR HARDWARE



SWING DOORS

Swing doors are made of high quality flexible PVC sheet, aluminum frames and galvanized or stainless steel hardware.

Swing doors are ideal for strong isolation needs, windy environments and esthetic entrance, ensuring safe and easy traffic flow.

DESIGN A SWING DOOR

ALUMINUM PROFILES

Standard surface finish :

- Anodized Silver.
- or
- White painted.



For coloured options, please contact us.

STEEL HARDWARE COMPONENTS

Hardware components are made in :

- Galvanized steel which ensures durability and protection against rust.
- or
- Top quality stainless steel which is especially good for food or chemical factories and aggressive environments.

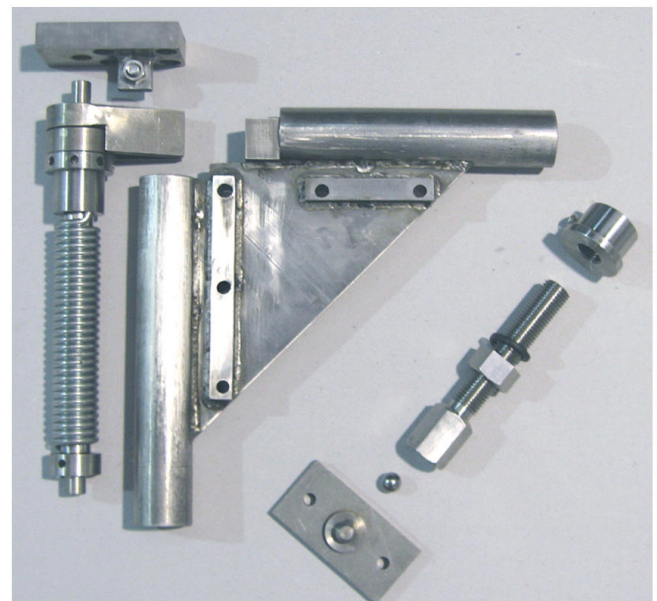

DOOR SIZE

All components are designed in two sizes :

- Small size: for small pedestrian opening which are under 2.5 m (H) x 2.5 m (W) (double leaf door), with flexible PVC sheet thickness from 4 to 7 mm.

Small & Large single leaf doors

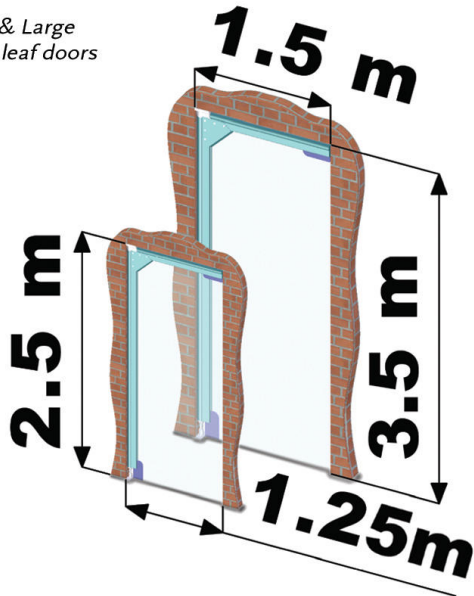

- Large size: reinforced for large opening up to 3.5 m (H) x 3m (W) (double leaf door) for vehicle traffic, with flexible PVC sheet thickness from 7 to 10 mm.

Small & Large double leaf doors

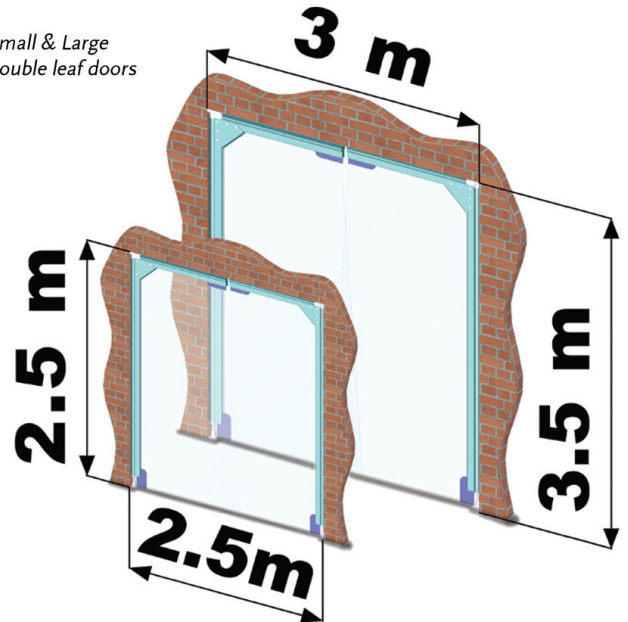

FLEXIBLE PVC SHEET QUALITY

Choose the correct flexible PVC grade according to the application needs:

- For temperature & noise controlStandard clear
- For heavy trafficReinforced
- For cool roomsPolar

***All our products are UV treated for anti ageing, non carcinogenic and odourless.**

CHOICE OF VISIBILITY

- Full transparent : Excellent visibility either side of the opening. (safety)
- Half transparent : The effects of loads contacting directly the bottom lower part opaque PVC sheet during passages are less visible.

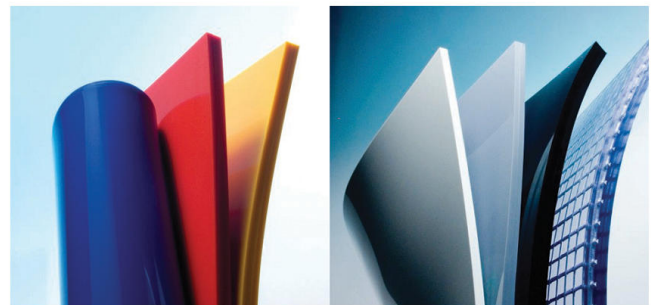

- Visibility strip : Partially obscures the view while ensuring sufficient visibility during passage.

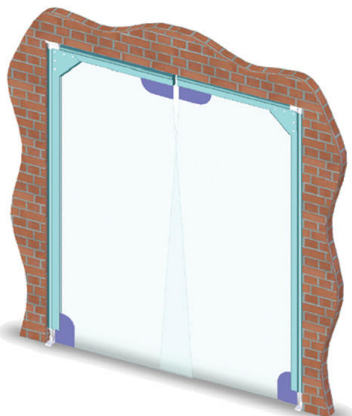

Full transparent

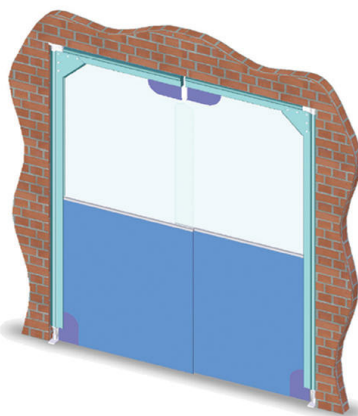

Half transparent

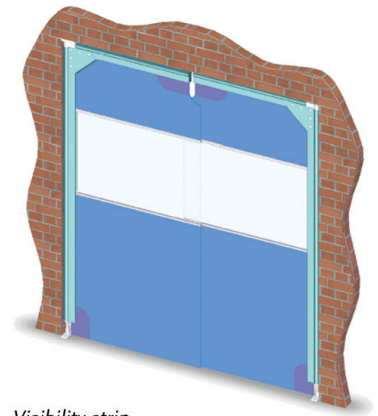

Visibility strip

SWING DOOR HARDWARE

TOP FIXTURE

Top fixture plate with alignment screw to adjust the tightness between the leaves.

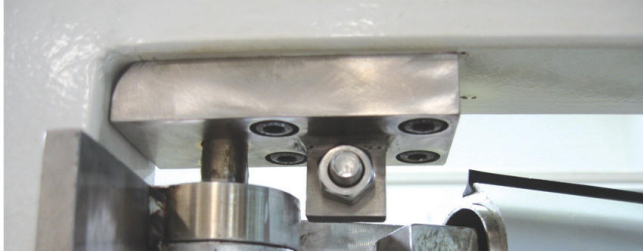

RETURN SPRING SYSTEM
Closing mechanism with adjustable torsion spring.

JUNCTION TUBES

For robust perpendicular assembly of the vertical and horizontal profiles.

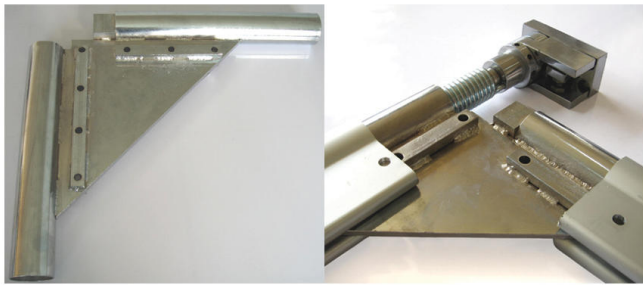

ALUMINUM PROFILE

Strong and elegant profile to support PVC sheet with safe round edges and screwless contact with the PVC sheet.

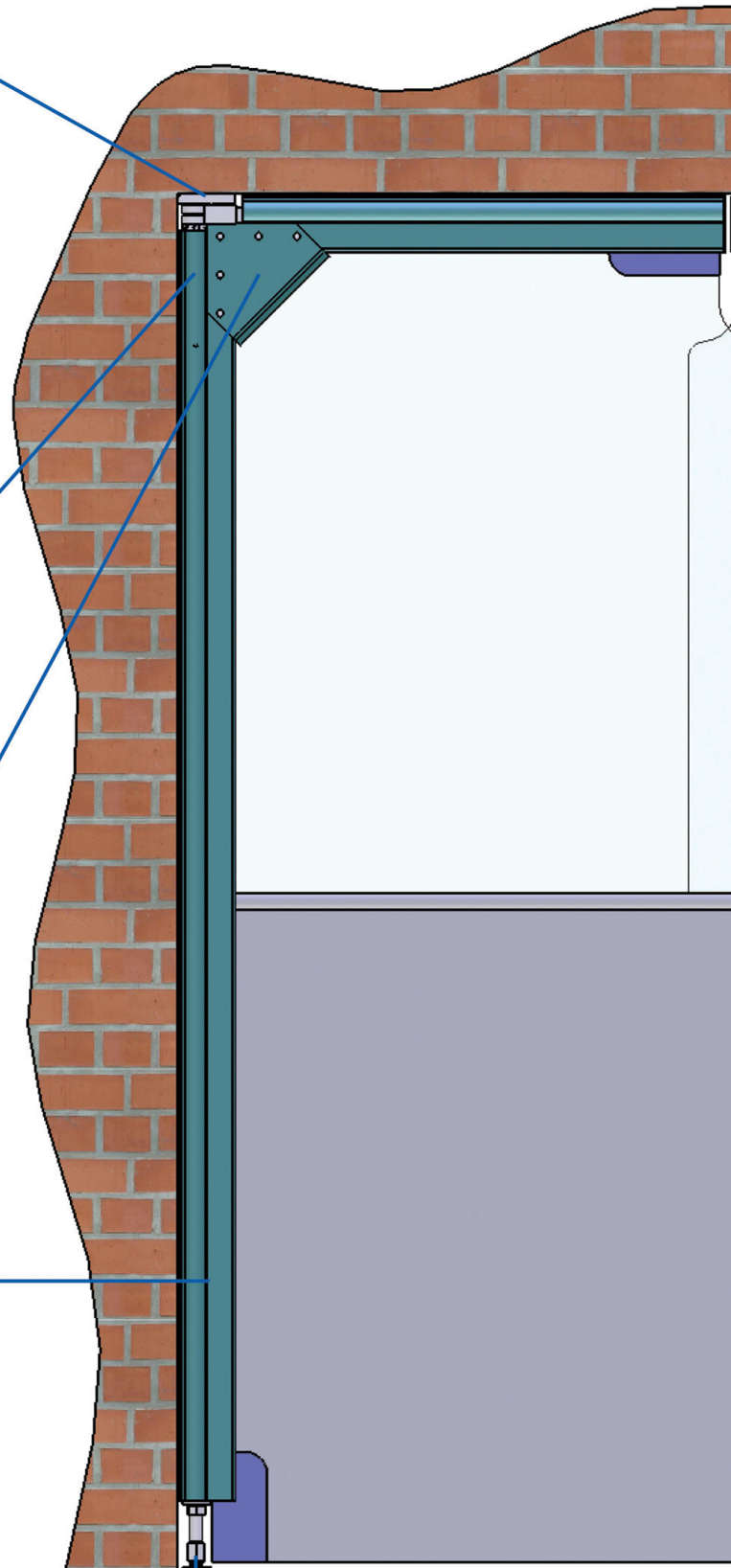
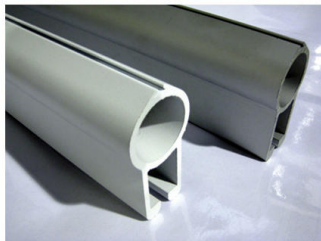

LOWER PIVOT & BOTTOM FIXTURE

Bottom plate with pivot for attaching to the floor with a height adjustment screw.

*Option: Rodents barrier.

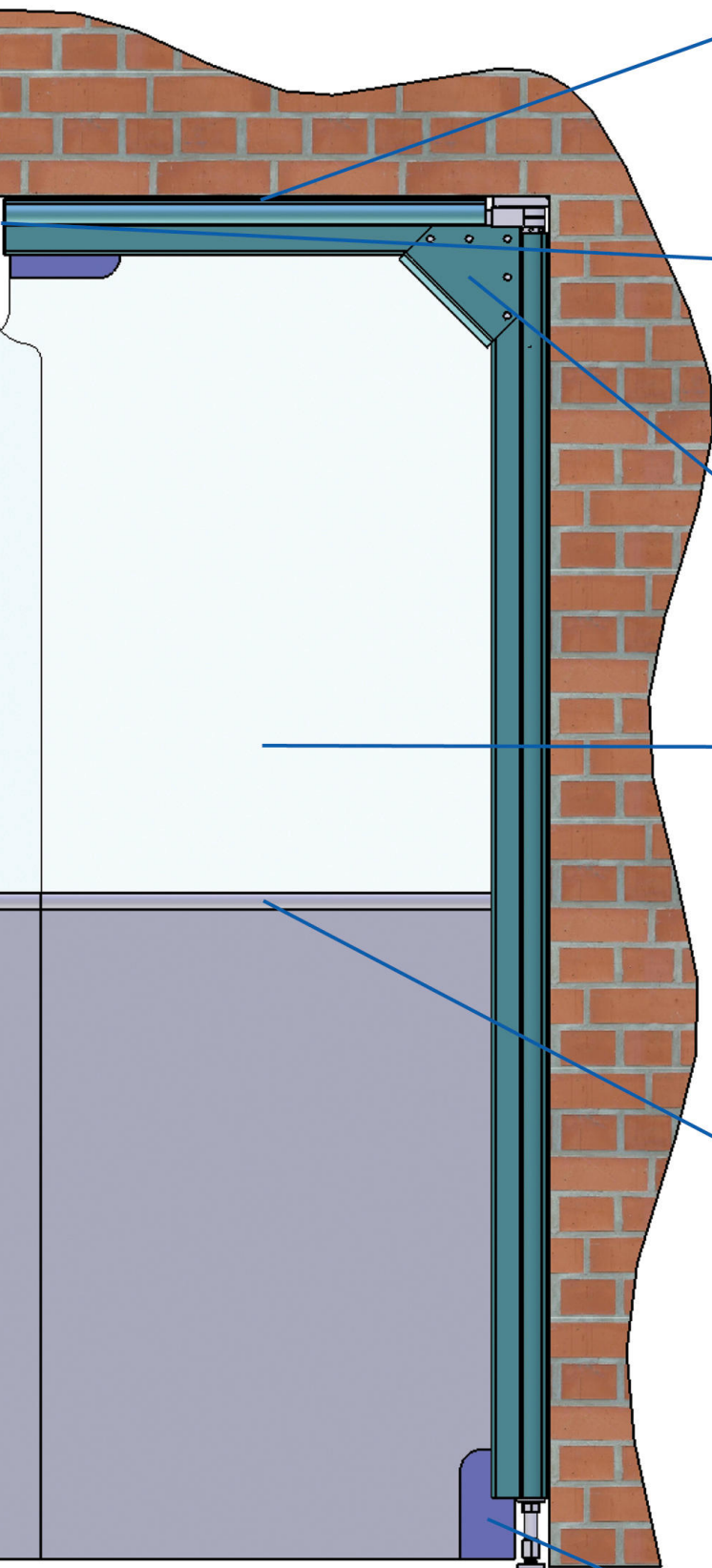

PVC SEAL
For perfect peripheral sealing.

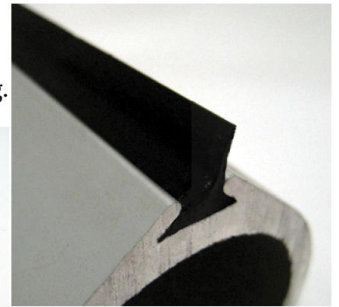

END PROFILE COVER
Esthetic finish.

CORNER PLATES
Provide a neat coverage for corner.



FLEXIBLE PVC SHEETS
Flexible sheets in thicknesses of 4 to 10 mm available in different colours & finishes to create individual doors.



JUNCTION SEAL
To join clear and opaque sheets.

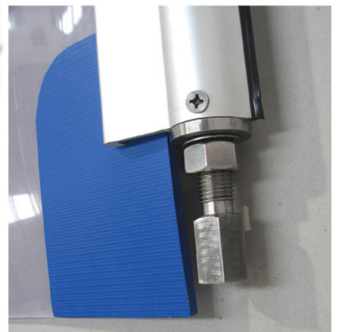

PVC COATED POLYESTER
To reinforce corners and edges of sheets to avoid damage.

HARDWARE COMPONENTS

STRIP DOORS & CURTAINS HARDWARE COMPONENTS

STANDARD DUTY HOOK-ON-TRACK

Material: Top quality stainless steel
3 standard lengths available : 984, 1230, 1968 mm



HEAVY DUTY HOOK-ON-TRACK WITH COVER

Material: Top quality stainless steel
Length : 984 mm

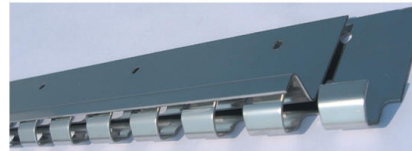

PLATE SETS

Material: Top quality stainless steel
Designed for strip width : 100, 200, 300, 400 mm



SWING DOOR HARDWARE COMPONENTS

HARDWARE BOX

includes all components for a double leaf door :

- 2 x Spring mechanism
- 2 x Top fixture
- 2 x Adjustment screw and bolt
- 2 x Bottom plate
- 2 x Junction tubes
- 4 x Aluminum corner plate
- 2 x Aluminum cover
- 2 x PVC weather seal
- 8 x PVC coated polyester reinforcement



Door model: Small or Large
Steel quality: Galvanized steel or Stainless steel
Aluminum surface finish: anodized Silver or White painted

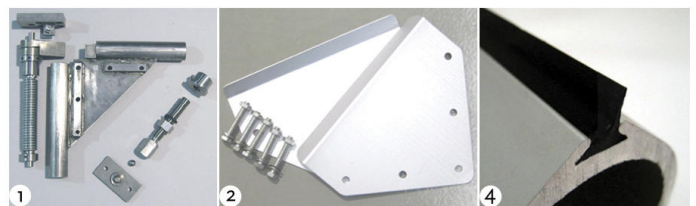

ALUMINUM PROFILES PACK

includes 2 profiles for a double leaf door.

Door model: Small or Large
Aluminum surface finish: anodized Silver or White painted

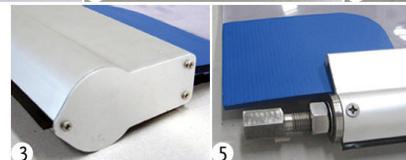

JUNCTION SEAL ROLL

Colour : Orange or Grey

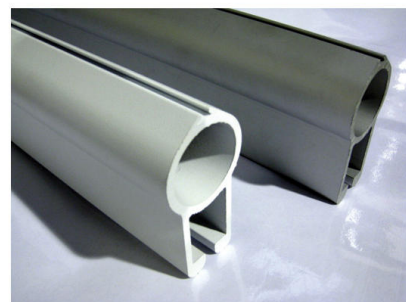

FROM COMPONENTS TO DOORS

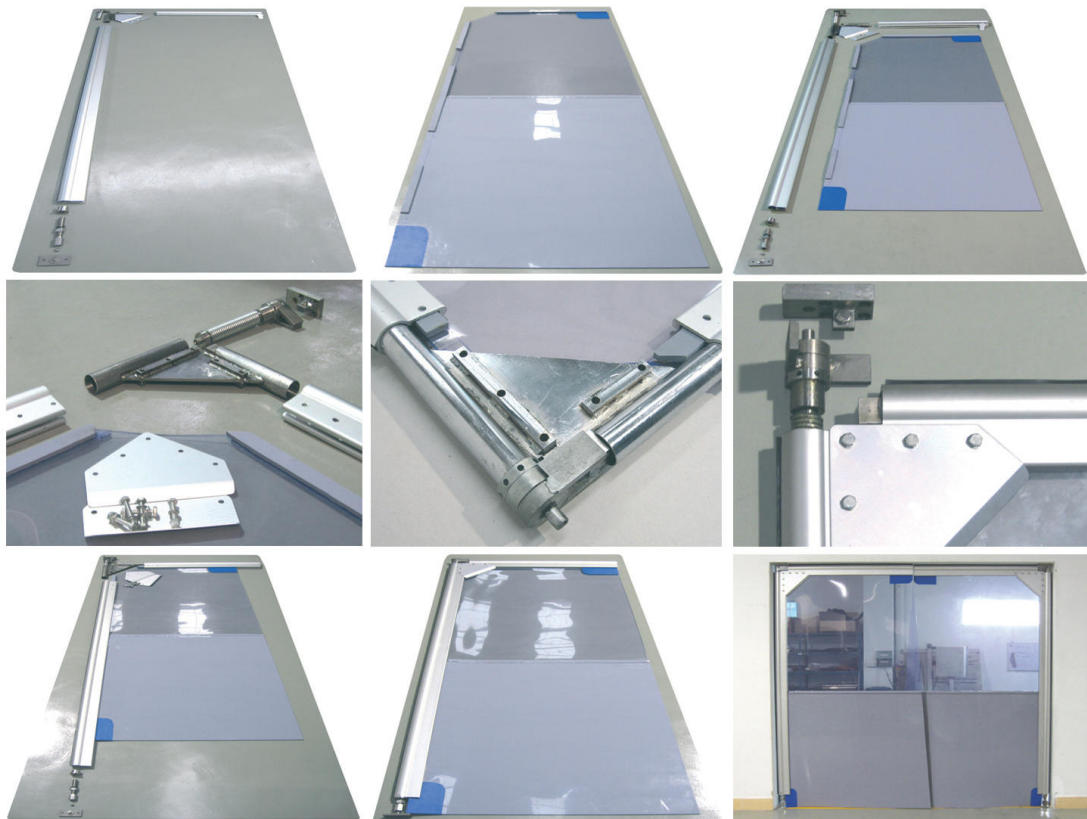
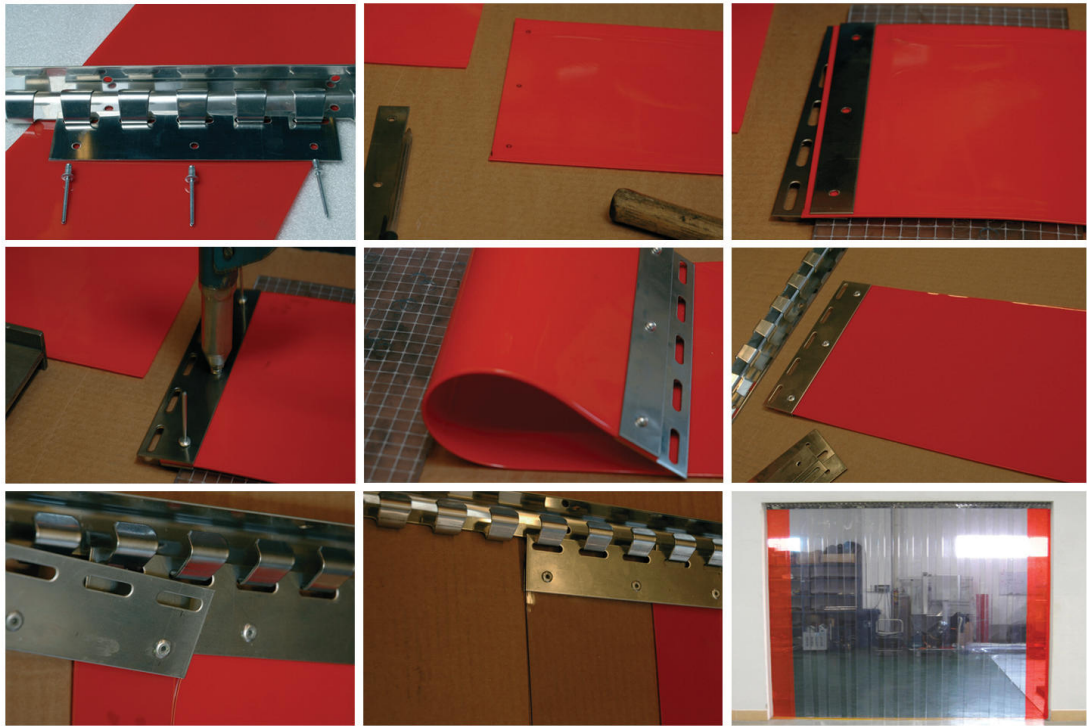

Marketing, production training and support can be arranged on request in order to become an EXTRUFLEX certified distributor.

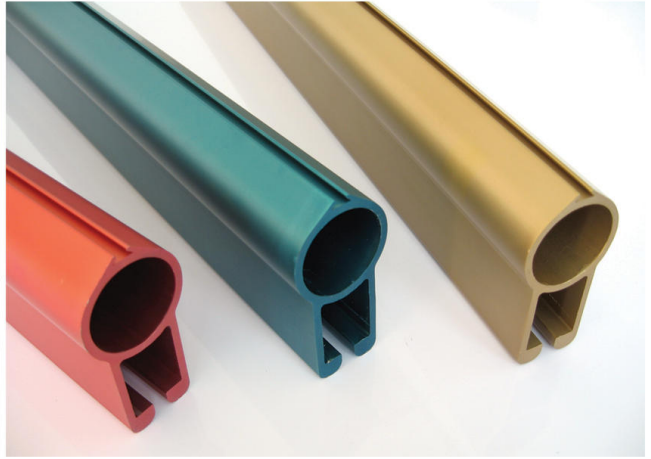

DISTRIBUTOR



EXTRUFLEX FRANCE



16, rue Baudin,
92300 Levallois Perret

FRANCE

Tel: +33(0)1 41499930
Fax: +33(0)1 47590333
extruflex@extruflex.com

EXTRUFLEX UK



Unit 5
Badminton Road
Trading Estate
Yate, Bristol, BS37 5NS
ENGLAND

Tel: +44 (0)1 454322335
Fax: +44 (0)1 454325671
sales@extruflex.co.uk

EXTRUFLEX GmbH



Ettore - Bugatti - Str. 13
51149 Köln

GERMANY

Tel: +49 22031024581
Fax: +49 22031024582
office@extruflex.de

EXTRUFLEX ITALY



Corso Martiri
della Libertà, 67
I-10073 CIRIE (TO)

ITALY

Tel: +39 0119206537
Fax: +39 0119226684
pecora.r@libero.it

EXTRUFLEX CHINA



No.1 Youcheng Road,
Xiaolan Industrial Zone,
Xiaolan, Zhongshan,
Guangdong
CHINA

Tel: +86 76022289088
Fax: +86 76022289089
info@zs-extruflex.com

www.extruflex.com

